

NOTE:
Please read all
instructions carefully
before using this product

Table of Contents

Safety Notice

Important Assembly
Information

Care and Maintenance

Parts List

Warranty

Ordering Parts

Model
ME-702

Retain This
Manual for
Reference

170706

**OWNER'S
MANUAL**

MARCY®

REGENERATING MAGNETIC UPRIGHT BIKE ME-702

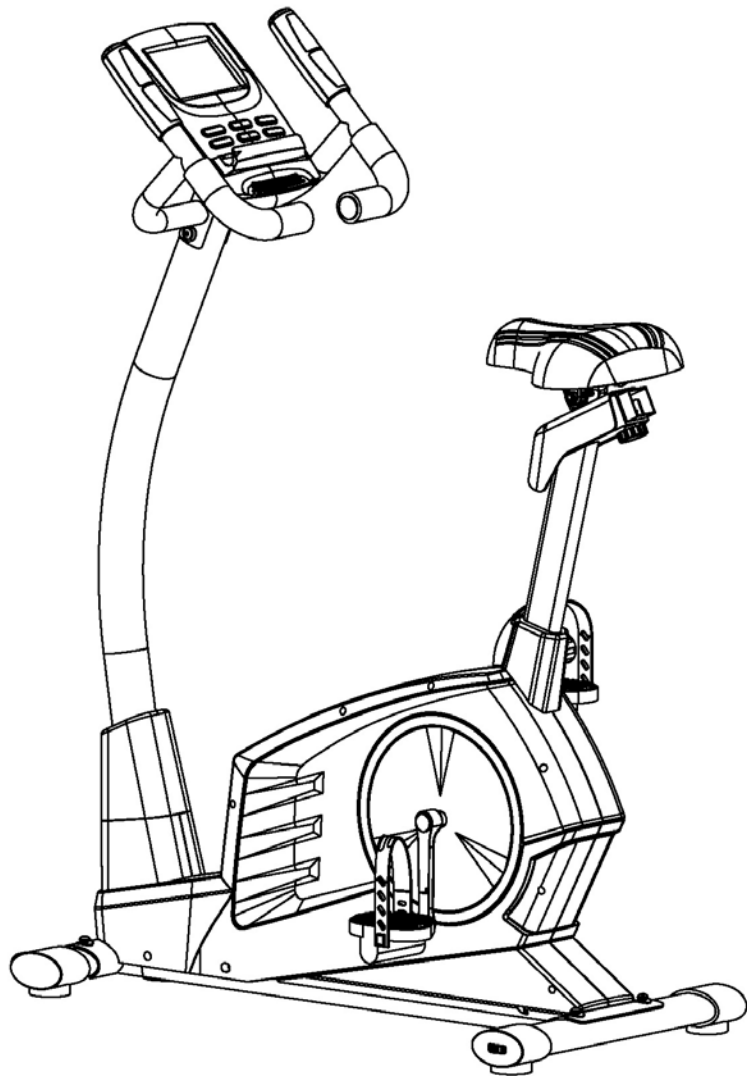

IMPORTANT: Please read this manual before commencing
assembly of this product.

IMPEX® INC.

2801 S. Towne Ave, Pomona, CA 91766

Tel: (800) 999-8899 Fax: (626) 961-9966

www.marcypro.com

support@impex-fitness.com

TABLE OF CONTENTS

BEFORE YOU BEGIN.....	1
IMPORTANT SAFETY NOTICES.....	2
EXERCISE GUIDELINES.....	3
WARNING LABEL PLACEMENT.....	5
IMPORTANT ASSEMBLY INFORMATION.....	6
CARE AND MAINTANENCE, WEIGHT CAPACITY, OPERATING NOTES	7
CONSOLE INSTRUCTIONS.....	8
PARTS LIST.....	15
EXPLODED DIAGRAM.....	17
WARRANTY.....	21
ORDERING PARTS.....	21

BEFORE YOU BEGIN

Thank you for selecting the MARCY REGENERATING MAGNETIC UPRIGHT BIKE ME-702 by IMPEX[®] INC. For your safety and benefit, read this manual carefully before using the equipment. As a manufacturer, we are committed to provide you complete customer satisfaction. If you have any questions, or find there are missing or damaged parts, we guarantee you complete satisfaction through direct assistance from our factory. To avoid unnecessary delays, *please call our TOLL-FREE customer service number.* Our Customer Service Agents will provide immediate assistance to you.

Toll-Free Customer Service Number

1-800-999-8899

Mon. – Fri. 9 a.m. – 5 p.m. PST

www.marcypro.com

support@impex-fitness.com

IMPORTANT SAFETY NOTICE

PRECAUTIONS

This exercise bike is built for optimum safety. However, certain precautions apply whenever you operate a piece of exercise bike. Be sure to read the entire manual before you assemble or operate your bike. In particular, note the following safety precautions:

Keep children and pets away from the machine at all times. DO NOT leave children unattended in the same room with the bike.

1. Only one person at a time should use the bike.
2. If the user experiences dizziness, nausea, chest pain, or any other abnormal symptoms, STOP the workout at once. CONSULT A PHYSICIAN IMMEDIATELY.
3. Position the machine on a clear, leveled surface. DO NOT use the bike near water or outdoors.
4. Keep hands away from all moving parts.
5. Always wear appropriate workout clothing when exercising. DO NOT wear robes or other clothing that could become caught in the bike. Running or aerobic shoes are also required when using the bike.
6. Use the machine only for its intended use as described in this manual. DO NOT use attachments not recommended by the manufacturer.
7. Do not place any sharp object around the bike.
8. Disabled person should not use the bike without a qualified person or physician in attendance.
9. Before using the bike to exercise, always do stretching exercises to properly warm up.
10. Never operate the machine if the bike is not functioning properly.
11. Read all warnings posted on the exercise bike.
12. Inspect the exercise bike for worn or loose component prior to use. Tighten/replace any
13. loose or wore components prior to use.
14. Care should be taken in mounting or dismounting the exercise bike.
15. **This exercise bike is for consumer and home use only.**

WARNING: BEFORE BEGINNING ANY EXERCISE PROGRAM, CONSULT YOUR PHYSICIAN. THIS IS ESPECIALLY IMPORTANT FOR INDIVIDUALS OVER THE AGE OF 35 OR PERSONS WITH PRE-EXISTING HEALTH PROBLEMS. READ ALL INSTRUCTIONS BEFORE USING ANY FITNESS EQUIPMENT. IMPEX INC. ASSUMES NO RESPONSIBILITY FOR PERSONAL INJURY OR PROPERTY DAMAGE SUSTAINED BY OR THROUGH THE USE OF THIS PRODUCT.

SAVE THESE INSTRUCTIONS.

EXERCISE GUIDELINES

Building Muscle and Gaining Weight

Unlike aerobic exercise, which emphasizes endurance training, anaerobic exercise focuses on strength training. A gradual weight gain can occur while building the size and strength of muscles. While developing muscle mass, your body adapts to the stress placed upon it. You can modify your diet to include foods such as meat, fish and vegetables. These foods help muscles recover and replenish important nutrients after a strenuous workout.

Muscle Strength and Endurance

To achieve the greatest benefit from exercise, it is important to develop an exercise program that allows you to work all of the major muscle groups equally.

To increase muscles strength; follow this principle:

Increasing resistance and maintaining the number of repetitions of an exercise results in increased muscle strength.

To tone your body, follow the principle: Decreasing resistance plus increasing the number of repetitions of an exercise results in increased body tone.

Once you feel comfortable with an exercise, you can change the resistance, the number of repetitions, or the speed at which you do the exercise. It is not necessary to change all three variables. For example, let's say that you are training at 50 lbs and performing the exercise 10 times in 3 minutes. When this becomes too easy, you may decide to move up lifting 60 lbs for the same number of repetitions in the same amount of time. Lifting more weights fewer times most often develops muscle strength. To gain both muscle strength and endurance, it is recommended that you perform each exercise 15 to 20 reps per set.

Training Intensity

How hard you begin to train depends on your overall level of fitness. The soreness you experienced can be lessened by decreasing the load you place on your muscles and by performing fewer sets. To avoid injury, you should gradually work into an exercise program and set the load to your individual fitness level. The load should increase as your fitness level increases.

Muscle soreness is common, especially when you first start exercising. If you are painfully sore for a long time, it may be time to change your program. Eventually, your muscle system will become accustomed to the stress and strain placed on it.

Beginning a Strength Building Program

Warming Up

To begin strength training, it is important to stretch and perform light exercise for 5 to 10 minutes. This helps prepare the body for more strenuous exercise by increasing circulation, raising your body temperature and developing more oxygen to your muscles.

Workout

Each workout to keep in mind that muscle soreness that lasts for a long period is not desirable and may mean that injury has occurred.

Cool Down

At the end of each workout, perform slow stretching exercises for 5 to 10 minutes. Ease into each stretch only going as far as you can. This stage allows your muscles wind down after training.

To provide a total workout program it is also recommended that 2 to 3 days of aerobic exercise is performed in addition to the strength training.

Drinking Water

For the body to function properly, it must be properly hydrated. If you are exercising, you should increase your fluid intake. The reason for this is that the water you take in will leave your system through the sweating mechanism that cools your body during exercise. The water you lose through exercise must be replaced so that the muscles can recover properly.

Rest Day

Although you may not feel like doing it, taking a rest day at least once a week is important because it gives your body a chance to heal itself. Continuously working your muscle will result in over training which will not benefit in the long run.

WARNING LABEL PLACEMENT

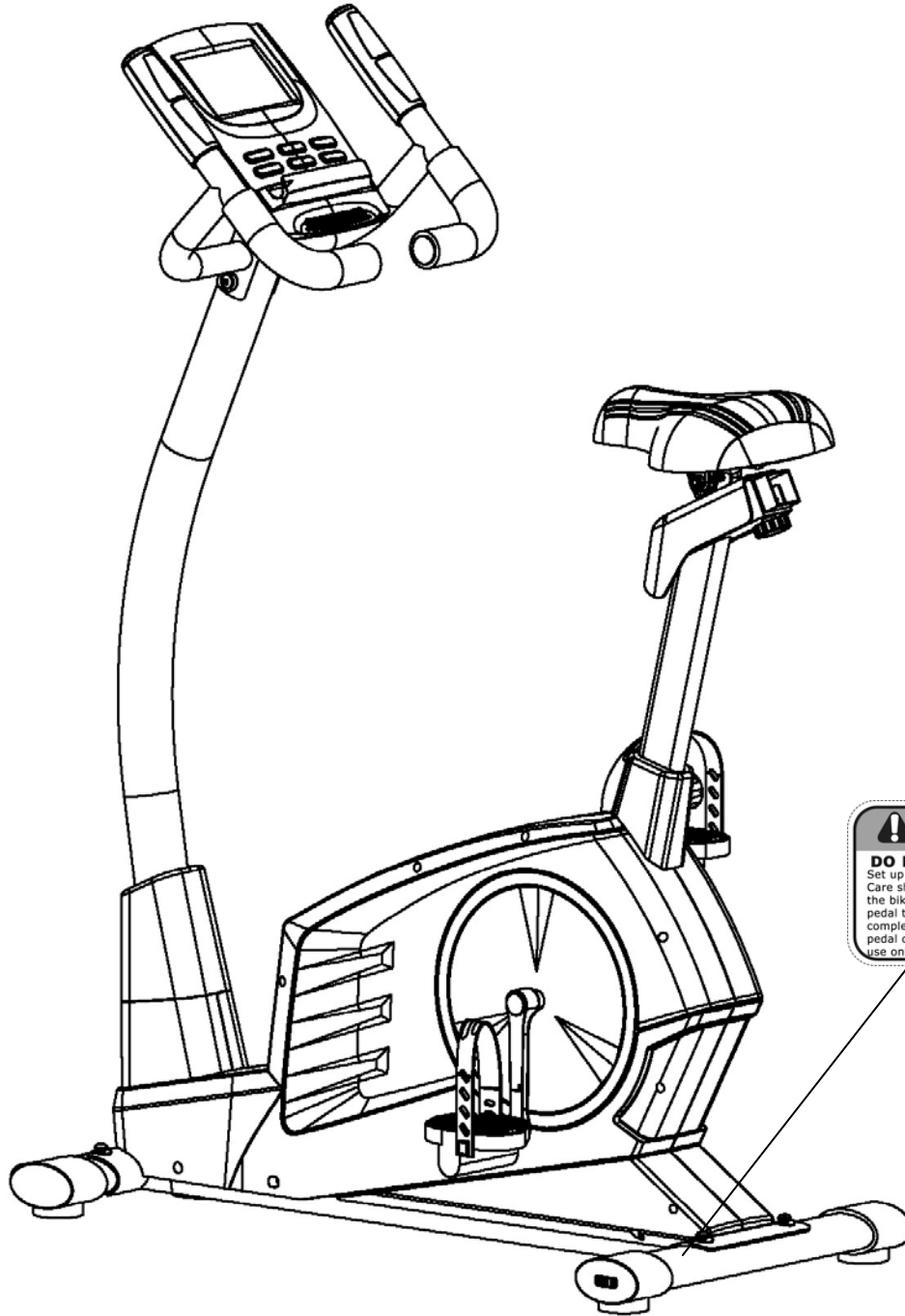

The warning labels shown here have been placed on the Base Frame. If the labels are missing or illegible, please call customer service at 1-800-888-8899 for replacements. Apply the labels in the location shown.

IMPORTANT ASSEMBLY INFORMATION

- ❖ Tools Required for Assembling the Bench: Two Adjustable Wrenches and Allen Wrenches.
- ❖ NOTE: It is strongly recommended that this equipment is assembled by two or more people to avoid possible injury.
- ❖ Ensure **Carriage Bolts** are inserted through the **SQUARE holes** on components that need to be assembled. Attach washer only to end of the Carriage Bolt.
- ❖ Use **Allen Bolts or Hex Bolts** inserted through the **ROUND hole** on components that need to be assembled.
- ❖ Always wait until all bolts are assembled onto the bench before tightening the bolts. Do not tighten each bolt right after it is installed

Fasten Nuts and Bolts

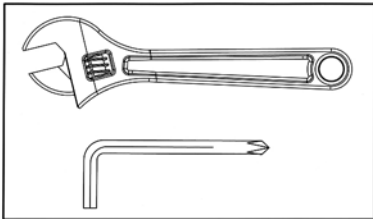

Securely tighten all Nuts and Bolts after all components have been assembled in current and previous steps.

NOTE: Do not over tighten any component with pivoting function.

Make sure all pivoting components are able to move freely.

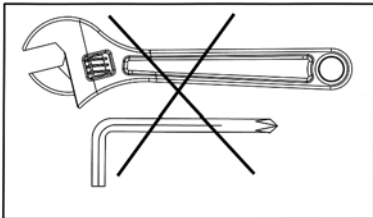

Do not tighten all Nuts and Bolts in this step.

CARE AND MAINTENANCE

1. Lubricate moving parts with WD-40 or light oil periodically.
2. Inspect and tighten all parts before using the equipment.
3. The equipment can be cleaned using a damp cloth and mild non-abrasive detergent.
DO NOT use solvents.
4. Examine the equipment regularly for signs of damages or wear.
5. Replace any defective components immediately and/or keep the equipment out of use until repair.
6. **Failure to examine regularly may affect the safety level of the equipment.**

WEIGHT CAPACITY AND DIMENSION

1. Maximum User weight: 300 lbs.
2. Assembled Dimension: 38"x20"x52"

CONSOLE INSTRUCTIONS



A. Program select and setting value

1. Use the UP or DOWN keys to select program mode then press ENTER to confirm your exercise mode.
2. In the Manual mode, use the UP or DOWN keys to set up your exercise TIME, DISTANCE, CALORIES, PULSE.
3. Press the START/STOP key to start exercise.
4. When you reach the target, the computer will beep then stop.
5. If you set up more than one target and you would like to reach next target, press START/STOP key to keep on exercising.

B. Wake-Up Function

The monitor will enter SLEEP mode (LCD off) after 4 minutes of inactivity. Press any button to start the monitor.

Functions and Features:

1. TIME: Shows your elapsed workout time in minutes and seconds. Your computer will automatically count up from 0:00 to 99:59 in one second intervals. You can also program your computer to count down from a set value by using the UP and DOWN keys. If you continue exercising once the time has reached 0:00, the computer will begin beeping, and reset itself to the original time set, letting you know your workout is completed.
2. DISTANCE: Displays the cumulative distance traveled during each workout up to a maximum of 99.9 MILE.
3. RPM: Your pedaling speed.
4. WATT: The amount of mechanical power the computer is receiving from your exercise.
5. SPEED: Displays your workout speed value in MILES per hour.
6. CALORIES: Your computer will estimate the cumulative calories burned at any given time during your workout.
7. PULSE: Your computer displays your pulse rate in beats per minute during your workout. Pulse function works with hand-pulse and chest belt (not included). The receiver inside of meter is compatible with Polar 5kHz chest belt
8. AGE: Your computer is age-programmable from 10 to 99 years. If you do not set an age, this function will always default to age 35.
9. TARGET HEART RATE (TARGET PULSE): The heart rate you should maintain is called your Target Hear Rate in beats per minute.
10. PULSE RECOVERY: During the START stage, leave the hands holding on grips or leave the chest transmitter attached and then press "PULSE RECOVERY" key, time starts counting from 00:60 - 00:59 - - to 00:00. As soon as 00:00 is reached, the computer will show your heart rate recovery status with the grade F1.0 to F6.0.

1.0 means OUTSTANDING

1.0 < F < 2.0 means EXCELLENT

2.0 ≤ F ≤ 2.9 means GOOD

3.0 ≤ F ≤ 3.9 means FAIR

4.0 ≤ F ≤ 5.9 means BELOW AVERAGE

6.0 means POOR

Note: If no pulse signal input then the computer will show "P" on the PULSE window. If the computer shows "ERR" on the message window, please press the PULSE RECOVERY key and place your hands on the pulse grip.

11. DISTANCE BAR: Every bar indicates 100 meter or 0.1 mile.

Key function:

There are 6 buttons as follows:

1. START/STOP key:

- a. Quick Start function: Allows you to start the computer without selecting a program. Manual workout only. Time automatically begins to count up from zero
- b. During the exercise mode, press the key to STOP exercise.
- c. During the stop mode, press the key to START exercise.

2. UP key:

- a. Press the key to increase the resistance during exercise mode.
- b. During the setting mode, press the key to increase the value of Time, Distance, Calories, Age and select Gender and Program.

3. DOWN key:

- a. Press the key to decrease the resistance during exercise mode.
- b. During the setting mode, press the key to decrease the value of Time, Distance, Calories, Age and select Gender and Program.

4. ENTER key:

- a. During the setting mode, press the key to accept the current data entry.
- b. At the stop mode, by holding this key for over two seconds the user can reset all values to zero or default value.
- c. During setting the Clock, press this key can accept the setting hour and setting minute.

5. BODY FAT key: Press the key to input your HEIGHT, WEIGHT, GENDER and AGE then to measure your body fat ratio,

6. PULSE RECOVERY key: Press the key to activate heart rate recovery function.

Program Introduction & Operation:

Manual Program: Manual

P1 is a manual program. User can start exercise by pressing START/STOP key. The default resistance level is 5. Users may exercise in any resistance level (Adjusting by UP/DOWN keys during the workout) with a period of time or a number of calories or a certain distance.

Operations:

1. Use UP/DOWN keys to select the MANUAL (P1) program.
2. Press the ENTER key to enter MANUAL program.
3. The TIME will flash and you can press UP or DOWN keys to set your exercise TIME. Press ENTER key to confirm your desired TIME.
4. The DISTANCE will flash and you can press UP or DOWN keys to set your target DISTANCE. Press ENTER key to confirm your desired DISTANCE.
5. The CALORIES will flash and you can press UP or DOWN keys to set your exercise CALORIES. Press ENTER key to confirm your desired CALORIES.
6. The PULSE will flash and then you can press UP or DOWN keys to set your exercise PULSE. Press ENTER key to confirm your desired Pulse.
7. Press the START/STOP key to begin exercise.

Preset Program: Steps, Hill, Rolling, Valley, Fat Burn, Ramp, Mountain, Intervals, Random, Plateau, Fartlek, Precipice Program

PROGRAM 2 to PROGRAM 13 is the preset programs. Users can exercise with different level of loading in different intervals as the profiles show. Users may exercise in any desirous of resistance level (Adjusting by UP/DOWN keys during the workout) with a period of time or a number of calories or a certain distance.

Operations:

1. Use UP/DOWN keys to select one of the above programs from P2 to P13.
2. Press the ENTER key to enter your workout program.
3. The TIME will flash and you can press UP or DOWN keys to setting your exercise TIME. Press ENTER key to confirm your desired TIME.
4. The DISTANCE will flash and you can press UP or DOWN keys to setting your target DISTANCE. Press ENTER key to confirm your desired DISTANCE.
- 5 The CALORIES will flash and you can press UP or DOWN keys to setting your exercise CALORIES. Press ENTER key to confirm your desired CALORIES.
6. The PULSE will flash and then you can press UP or DOWN keys to set your exercise PULSE. Press ENTER key to confirm your desired Pulse.

7. Press the START/STOP key to begin exercise.

User Setting Program: User 1, User 2, User 3, User 4

Program 14 to 17 is the user setting program. Users are free to create the values in the order of TIME, DISTANCE, CALORIES and the resistance level in 10 columns. The values and profiles will be stored in the memory after setup. Users may also change the ongoing loading in each column by UP/DOWN keys, and they will not change the resistance level stored in the memory.

Operations:

1. Use UP/DOWN keys to select the USER program from P14 to P17.
2. Press the ENTER key to enter your workout program.
3. The column 1 will flash, and then use the UP/DOWN keys to create your personal exercise profile. Press ENTER to confirm your first column of exercise profile. The default level is load 1.
4. The column 2 will flash, and then use the UP/DOWN keys to create your personal exercise profile. Press ENTER to confirm your second column of exercise profile.
5. Follow the above description 5 and 6 to finish your personal exercise profiles. Press ENTER to confirm your desired exercise profile.
6. The TIME will flash and you can press UP or DOWN keys to set your exercise TIME. Press ENTER key to confirm your desired TIME.
7. The DISTANCE will flash and you can press UP or DOWN keys to set your target DISTANCE. Press ENTER key to confirm your desired DISTANCE.
8. The CALORIES will flash and you can press UP or DOWN keys to set your exercise CALORIES. Press ENTER key to confirm your desired CALORIES.
9. The PULSE will flash and then you can press UP or DOWN keys to set your exercise PULSE. Press ENTER key to confirm your desired Pulse.
10. Press the START/STOP key to begin exercise.

Heart Rate Control Program: 55% H.R.C., 65% H.R.C., 75% H.R.C., 85% H.R.C., Target H.R.C.

Program 18 to Program 22 is the Heart Rate Control Programs and Program 22 is the Target Heart Rate Control program.

Program 18 is the 55% Max H.R.C. - - Target H.R. = $(220 - \text{AGE}) \times 55\%$

Program 19 is the 65% Max H.R.C. - - Target H.R. = $(220 - \text{AGE}) \times 65\%$

Program 20 is the 75% Max H.R.C. - - Target H.R. = $(220 - \text{AGE}) \times 75\%$

Program 21 is the 85% Max H.R.C. - - Target H.R. = $(220 - \text{AGE}) \times 85\%$

Program 22 is the Target H.R.C. - - Workout by your target heart rate value.

Users can exercise according to your desired Heart Rate program by setting your AGE, TIME, DISTANCE, CALORIES or TARGET PULSE. In these programs, the computer will adjust the resistance level according to the heart rate detected. For example, the resistance level may increase every 20 seconds while the heart rate detected is lower than the TARGET H.R.C. Also the resistance level may decrease every 20 seconds while the heart rate detected is higher than the TARGET H.R.C.

Operations:

1. Use UP/DOWN keys to select one of the heart rate control program from P18 to P22.
2. Press the ENTER key to enter your workout program
3. The AGE will flash at P18 to P21 programs and you can press UP or DOWN keys to set your AGE. The default age is 35.
4. At program 22, the TARGET PULSE will flash and you can press UP or DOWN keys to set your TARGET PULSE between 80 to 180. The default TARGET PULSE is 120.
5. The TIME will flash and you can press UP or DOWN keys to set your exercise TIME. Press ENTER key to confirm your desired TIME.
6. The DISTANCE will flash and you can press UP or DOWN keys to set your target DISTANCE. Press ENTER key to confirm your desired DISTANCE.
7. The CALORIES will flash and you can press UP or DOWN keys to set your exercise CALORIES. Press ENTER key to confirm your desired CALORIES.
8. Press the START/STOP key to begin exercise.

Watt Control Program: Watt Control

Program 23 is a Speed Independent Program. Press ENTER key to set up the values of TARGET WATT, TIME, DISTANCE and CALORIES. During the exercise mode, the level of resistance is not adjustable. For example, the level of resistance may increase while the speed is too slow. Also the level of resistance may decrease while the speed is too fast. As a result, the calculated value of WATT will close to the value of TARGET WATT setup by users.

Operations:

1. Use UP or DOWN key to select the WATT CONTROL (P23) program.
2. Press ENTER key to enter your workout program.
3. The TIME will flash and you can press UP or DOWN key to set your exercise TIME. Press ENTER key to confirm your desired TIME.
4. The DISTANCE will flash and you can press UP or DOWN key to set your target DISTANCE. Press ENTER key to confirm your desired DISTANCE.
5. The WATT will flash and you can press UP or DOWN key to set your target WATT value. Press ENTER key to confirm your target WATT. The default WATT value is 100.
6. The CALORIES will flash and you can press UP or DOWN key to set your exercise CALORIES. Press ENTER key to confirm your desired CALORIES.
7. The PULSE will flash and then you can press UP or DOWN keys to set your exercise PULSE. Press ENTER key to confirm your desired Pulse.
8. Press the START/STOP key to begin exercise.

NOTE: 1. $WATT = TORQUE (KGM) * RPM * 1.03$

2. In this program, the WATT value will keep constant value. It means that if you peddle quickly, the resistance level will decrease and if you peddle slowly, the resistance level will increase. Always try to keep you in the same watt value.

Body Fat Program: Body Fat

Program 24 is a special program design to calculate users' body fat ratio and to offer a specific loading profile for users. There are 3 body types divided according to the FAT% calculated.

Type1: $BODY\ FAT\% > 27$

Type2: $27 \geq BODY\ FAT\% \geq 20$

Type3: $BODY\ FAT\% < 20$

The computer will show the test results of FAT PERCENT

Operations:

1. Use UP/DOWN keys to select the BODY FAT (P24) program.
2. Press the ENTER key to enter your workout program.
3. The HEIGHT will flash and you can press UP or DOWN keys to set your HEIGHT. Press ENTER key to confirm your HEIGHT. The default HEIGHT is 170cm or 5'07" (5feet 7 inches).
4. The WEIGHT will flash and you can press UP or DOWN keys to set your WEIGHT. Press ENTER key to confirm your WEIGHT. The default WEIGHT is 70kgs or 155lbs.
5. The GENDER will flash and you can press UP or DOWN keys to select your sex. Number 1 means man and number 0 means female. Press ENTER key to confirm your Gender. The default sex is 1 (MAN).
6. The AGE will flash and you can press UP or DOWN keys to set your AGE. Press ENTER key to confirm your AGE. The default AGE is 35.
7. Press the START/STOP key to begin body fat measurement. If the window show E on the window, please make sure your hands are attached well on the grips or the chest belt is touch well on your body. Then press the START/STOP key again to begin body fat measurement.
8. After finished your measurement, the computer will show the values of FAT PERCENT on the LCD display.
9. Press START/STOP key to begin exercise.

Operation guide:

1. **Sleep Mode:**

The computer will enter the sleep mode when there is no signal input and no keys be pressed after 4 minutes. You can press any key to wake up the computer.

Error Message:

E1 (ERROR 1):

Normal state: During workout, when the monitor did not get the count signal from the gear motor more than 4 seconds and check under successive 3 times then the LCD will show E1.

Power on state: The gear motor will return to zero automatically, when the signal of motor cannot be detected for more than 4 seconds then the gear motor's driver will be cut off immediately and show the E1 on the LCD display. All the other digital and function mark are blank, and the output signals are cut off also.

E2 (ERROR 2): When the monitor read the memory data, if the I.D. code is not correct or the memory IC damages then the monitor will show E2 immediately at power on.

E3 (ERROR 3): After 4 seconds by start mode, the computer detects the faulty motor did not leave the zero point then the LCD bar displays "E3".

LCD Workout Graphics

PRESET PROGRAM PROFILES:

PROGRAM 1

MANUAL

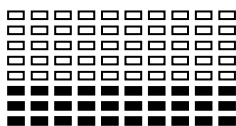

PROGRAM 2

STEPS

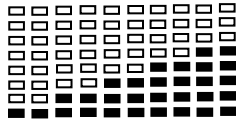

PROGRAM 3

HILL

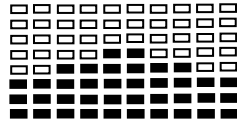

PROGRAM 4

ROLLING

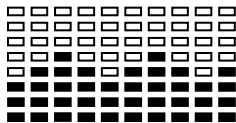

PROGRAM 5

VALLEY

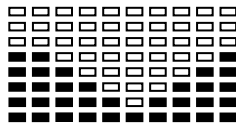

PROGRAM 6

FAT BURN

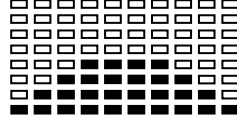

PROGRAM 7

RAMP

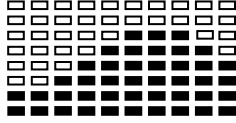

PROGRAM 8

MOUNTAIN

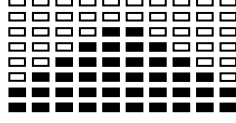

PROGRAM 9

INTERVALS

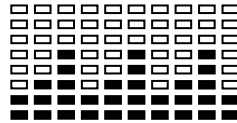

PROGRAM 10

RANDOM

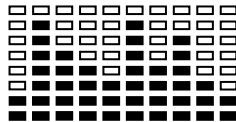

PROGRAM 11

PLATEAU

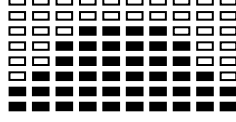

PROGRAM 12

FARTLEK

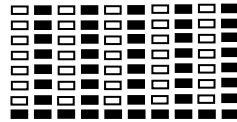

PROGRAM 13

PRECIPICE

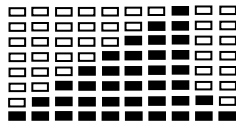

USER SETTING PROGRAM

PROGRAM 14

USER 1

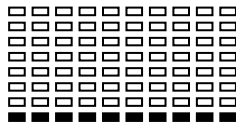
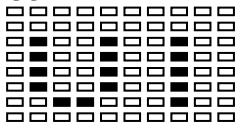

PROGRAM 15

USER 2

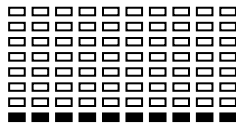
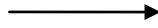
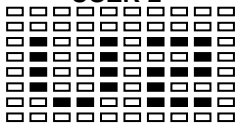

PROGRAM 16

USER 3

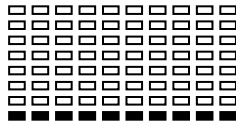
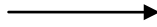
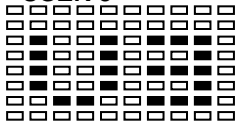

PROGRAM 17

USER 4

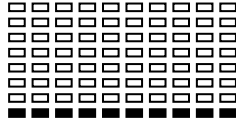
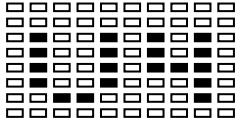

HEART RATE PROGRAM PROFILES:

PROGRAM 18

55% H.R.C.

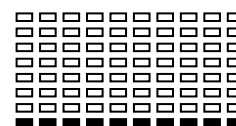
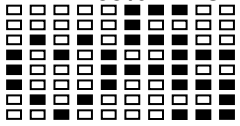

PROGRAM 19

65% H.R.C.

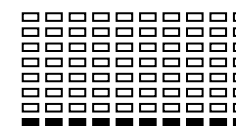
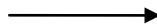
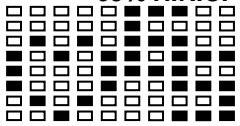

PROGRAM 20

75% H.R.C.

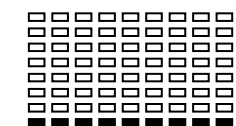
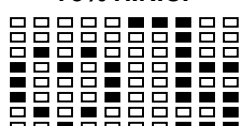

PROGRAM 21

85% H.R.C.

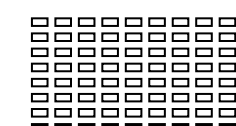
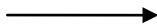
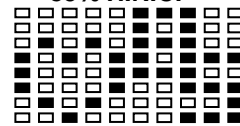

PROGRAM 22

TARGET H.R.C.

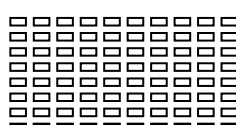
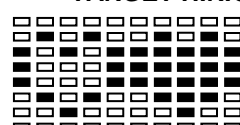

WATT CONTROL PROGRAM

PROGRAM 23

WATT CONTROL

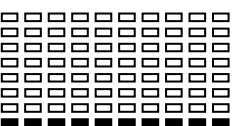
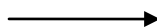
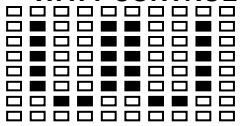

BODY FAT TEST PROGRAMS:

PROGRAM 24

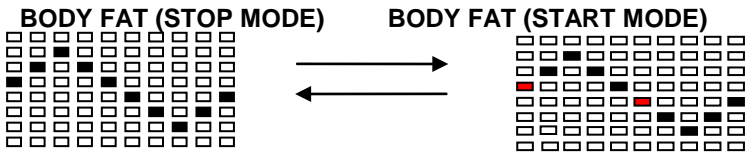

One of the Following Six Profiles Will Display Automatically after Measuring Your BODY FAT:

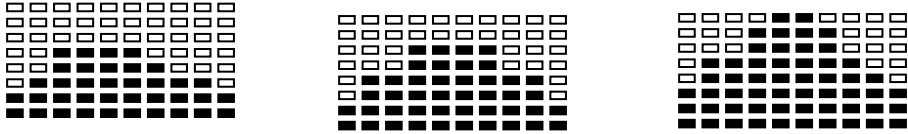

Workout Time: 40 minutes Workout Time: 40 minutes Workout time: 20 minutes

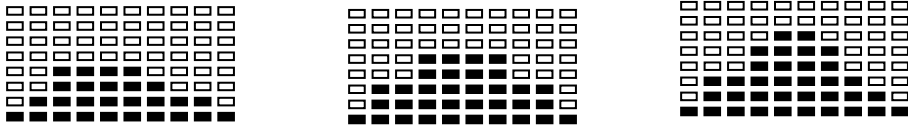

Workout Time: 40 minutes Workout Time: 40 minutes Workout time: 20 minutes

PARTS LIST

Part No.	Description	Q'ty
1	Main frame	1
2	Front stabilizer	1
3	Rear stabilizer	1
4	Front post	1
5	Left handlebar	1
6	Console	1
7	Seat post	1
8	Seat	1
9	Left pedal	1
10	Right pedal	1
11	Quick release knob	1
12	Cover for sliding tube	1
13	Sliding tube	1
14	U bracket	1
15	Allen screw M8 x 2"	4
16	Curved washer	12
17	Cover for seat post	1
18	Allen screw M8 x $\frac{5}{8}$ "	8
19	Lock washer	4
20	Hand pulse wire	2
21	Right handlebar	1
22	End cap for handlebar	2
23	End cap for front stabilizer L/R	1/1
24	End cap for rear stabilizer	2
25	Foam grip for handlebar	2
26	End cap for handlebar	2
27	Phillip screw M5 x $\frac{3}{8}$ "	4
28	Upper hand pulse sensor	2
29	Lower hand pulse sensor	2
30	Screw M2.5	4
31	Generator	2
32	Ring	1
33	Middle computer wire	1
34	Lower computer wire	1
35	Washer	2
36	Lock knob	1
37	Axle for pulley	1
38	Cover for front post	1
39	Motor	1
40	Self-tapping screw	7
41	End cap	1
42	Power wire	1
43	Motor cable	1
44	Sensor wire	1
45	Main Chain cover L/R	1/1

46	End cap for crank	2
47	Flange screw	2
48	Left crank	1
49	Right crank	1
50	Belt	1
51	Right chain cover	1
52	Left chain cover	1
53	Sensor bracket	1
54	Allen Bolt M6 x ½"	4
55	Self-tapping screw ST5 x ½"	15
56	Bushing for seat post	1
57	Flange nut	2
58	C-clip Φ½"	2
59	Axle for flywheel	1
60	Flywheel	1
61	Magnet assembly	1
62	Nylon nut M8	2
63	Hex bolt M8 x 2"	1
64	C-clip Φ ⁵ / ₈ "	2
65	Bearing 6203	2
66	Hex bolt M6 x 1"	1
67	Aircraft Nut M6	2
68	Spring for magnet assembly	1
69	Spring for idler wheel	1
70	Eye bolt	1
71	Nut M8	1
72	Idler wheel	1
73	Spacer	1
74	Pulley	1
75	Nylon nut M6	4
76	Audio wire	1

EXPLODED DIAGRAM

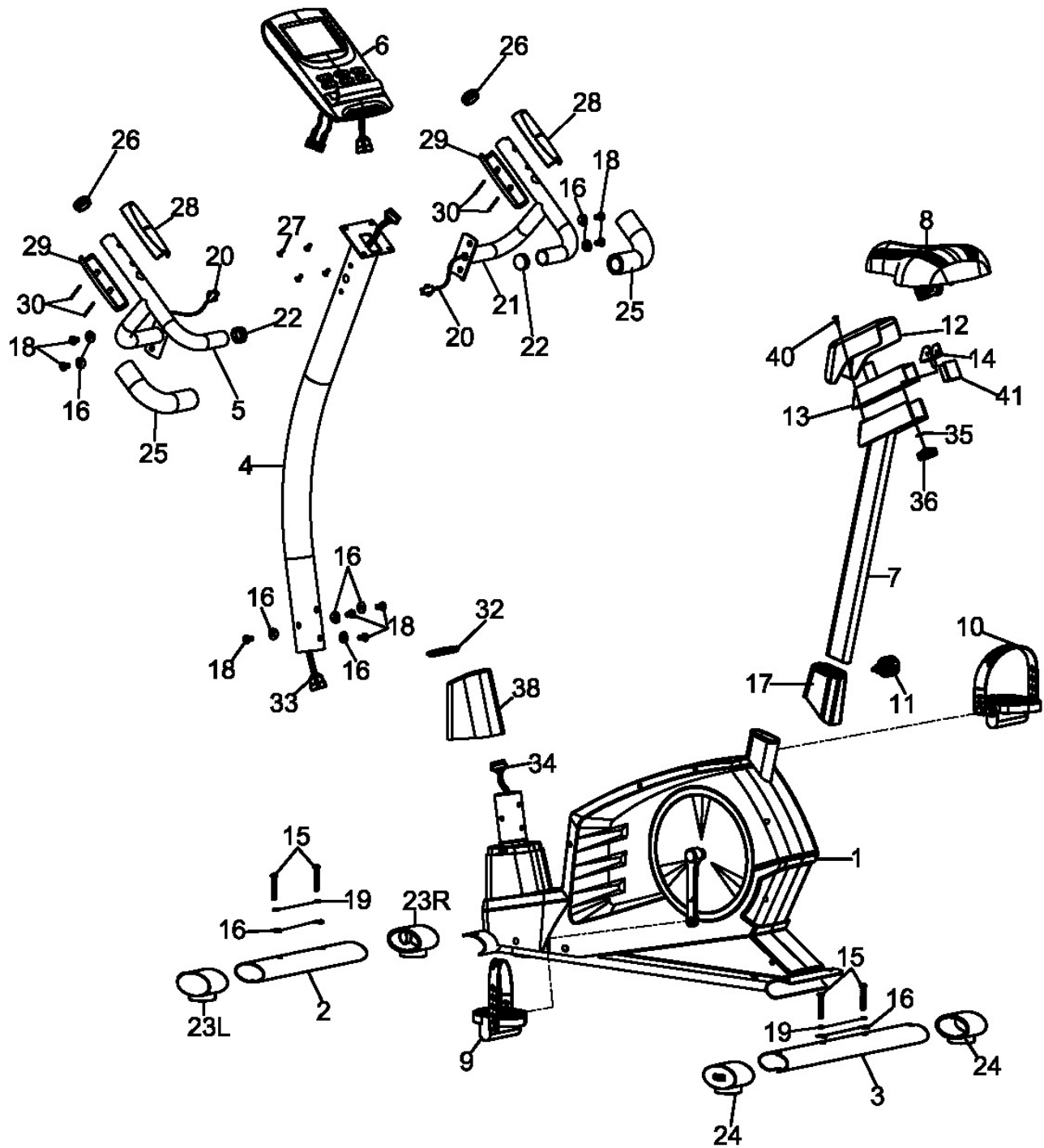

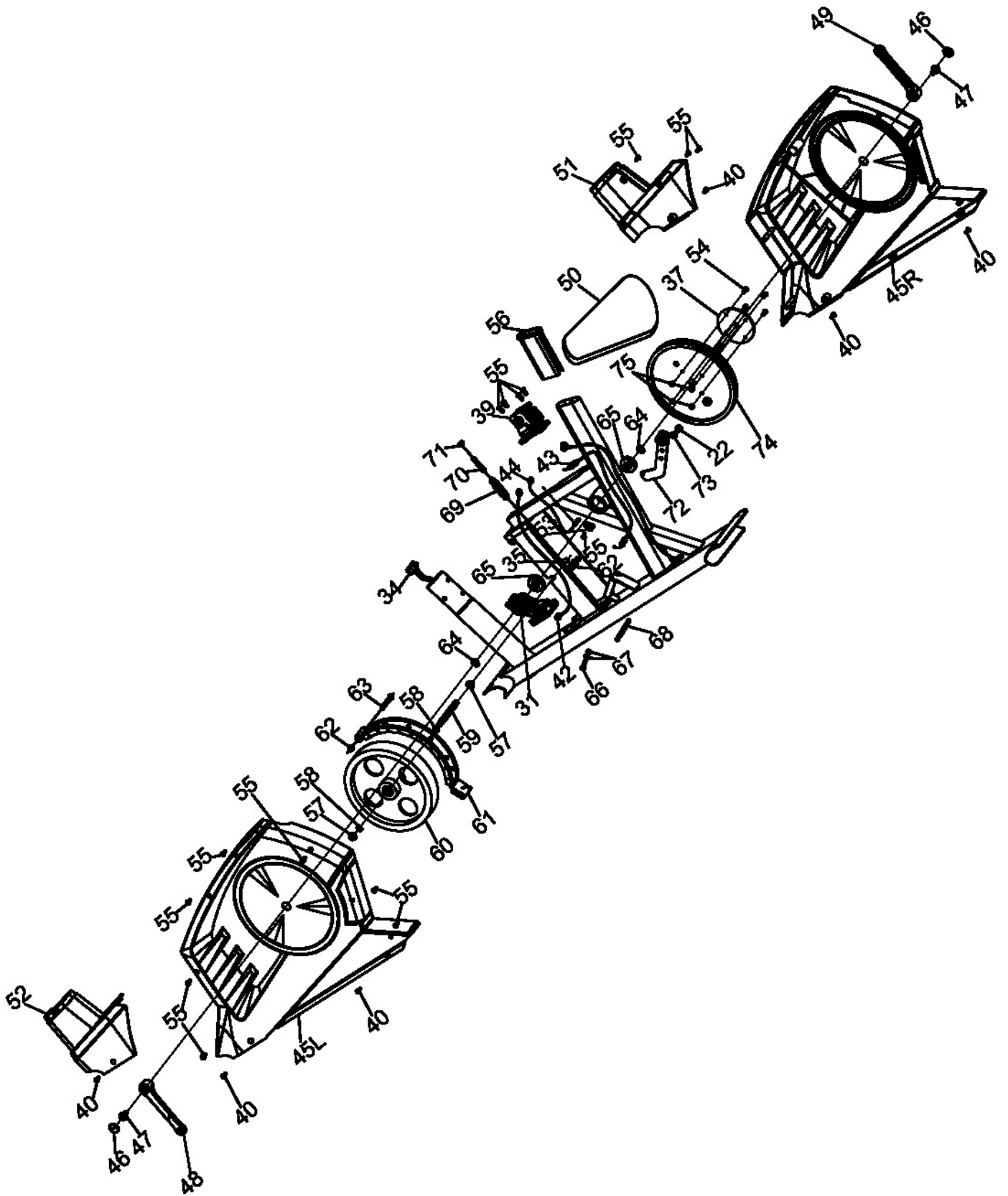



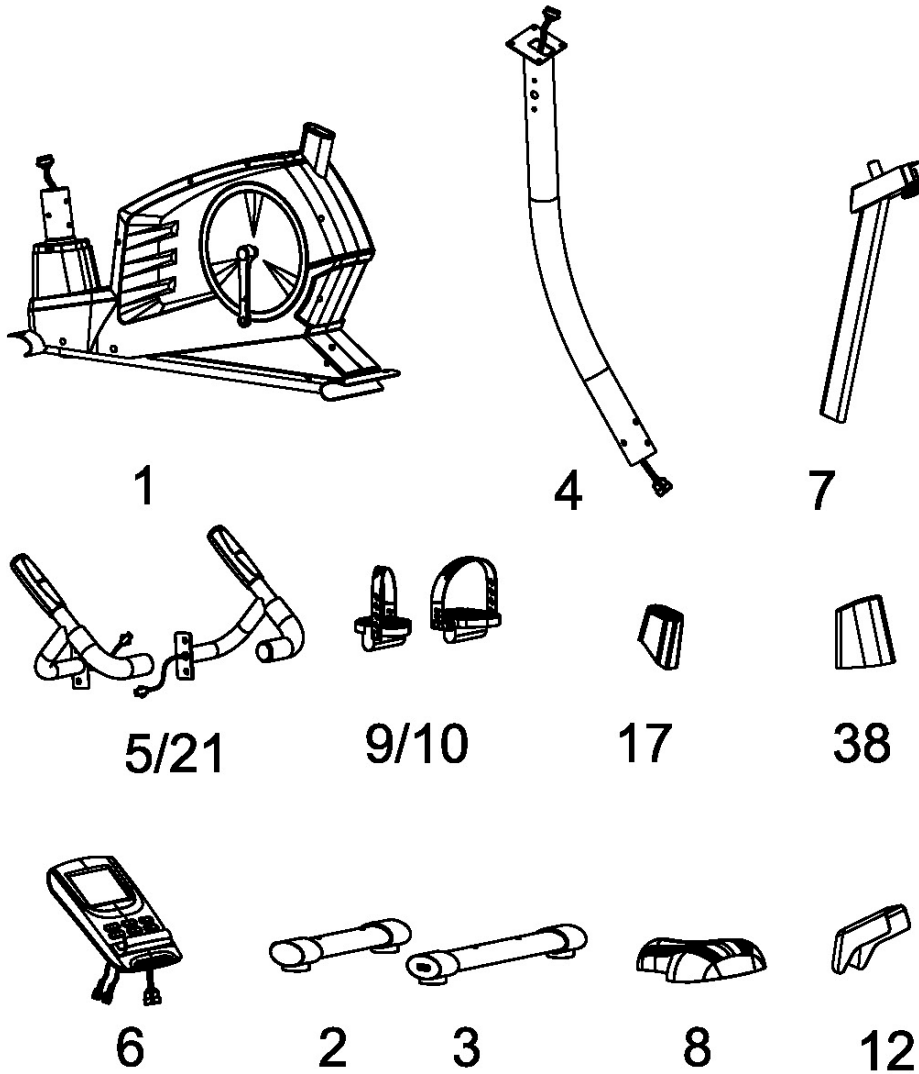

PRE-ASSEMBLY CHECK LIST

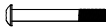

PART NO.	DESCRIPTION	Q'TY
1	Main frame	1
2/3	Front / Rear stabilizer	1 / 1
4	Front post	1
5/21	Left / Right handlebar	1 / 1
6	Console	1
7	Seat post	1
8	Seat	1
9/10	Pedal L/R	1
12	Cover for sliding tube	1
17	Cover for seat post	1
38	Cover for front post	1
	Hardware bag	1
	Manual	1

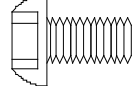
HARDWARE PARTS LIST

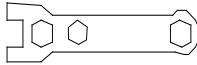
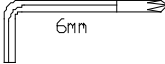
No.	Description	Drawing	Q'ty
11	Quick release knob		1
15	Allen screw M8 x 2"		4
16	Curved washer		12
18	Allen screw M8 x 5/8"		8
19	Lock washer		4
	Box Wrench		1
	Allen key #6		1

Above described parts are all the parts you need to assemble this machine. Before you start to assemble, please check the hardware packing to make sure they are included.

IMPEX[®] INC.

LIMITED WARRANTY

IMPEX Inc. ("IMPEX[®]") warrants this product to be free from defects in workmanship and material, under normal use and service conditions, for a period of two years on the Frame from the date of purchase. This warranty extends only to the original purchaser. IMPEX's obligation under this Warranty is limited to replacing or repairing, at IMPEX's option.

All returns must be pre-authorized by IMPEX. Pre-authorization may be obtained by calling IMPEX Customer Service Department at 1-800-999-8899. All freights on products returned to IMPEX must be prepaid by the customer. This warranty does not extend to any product or damage to a product caused by or attributable to freight damage, abuse, misuse, improper or abnormal usage or repairs not provided by an IMPEX authorized service center or for products used for commercial or rental purposes. No other warranty beyond that specifically set forth above is authorized by IMPEX.

IMPEX is not responsible or liable for indirect, special or consequential damages arising out of or in connection with the use or performance of the product or other damages with respect to any economic loss, loss of property, loss of revenues or profits, loss of enjoyments or use, costs of removal, installation or other consequential damages or whatsoever natures. Some states do not allow the exclusion or limitation of incidental or consequential damages. Accordingly, the above limitation may not apply to you.

The warranty extended hereunder is in lieu of any and all other warranties and any implied warranties of merchantability or fitness for a particular purpose is limited in its scope and duration to the terms set forth herein. Some states do not allow limitations on how long an implied warranty lasts. Accordingly, the above limitation may not apply to you.

This warranty gives you specific legal right. You may also have other rights which vary from state to state.

Register on-line at www.marcypro.com

IMPEX[®] INC.
2801 S. Towne Ave.
Pomona, CA 91766

ORDERING REPLACEMENT PARTS

Replacement parts can be ordered by calling our Customer Service Department toll-free at **1-800-999-8899** during our regular business hours: Monday through Friday, 9 am until 5 pm Pacific standard time.

support@impex-fitness.com

When ordering replacement parts, always give the following information.

1. Model
2. Description of Parts
3. Part Number
4. Date of Purchase